

## DIGITAL STEEL FIRE & SECURITY SAFE



Read this manual carefully and never store it inside the safe!

**PACKAGE CONTENTS**

- 1 – Digital Steel Fire & Security Safe
- 1 – Operation Manual
- 4 – “AA” Batteries
- 2 – Override Access Keys
- 1 – Silica Gel Pack
- 1 – Removable Drawer Tray

**ATTENTION**

**DO NOT RETURN SAFE TO STORE!**

For missing parts or difficulty operating your safe, please contact our Consumer Assistance Department by telephone.

Store will not accept returned products without prior authorization. You must first contact our consumer assistance department.

US/Canada 1-877-354-5457 (Toll Free)

Mexico 01-800-288-2872 After English voice recording stops you must then enter 800-860-1677 to complete your call. (Toll Free)

Australia 0011-800-5325-7000 (Toll Free)

Germany/New Zealand 00-800-5325-7000 (Toll Free)

Other Countries XX\*-310-323-5722

XX\*- Dial U.S. Country Code first (Toll Charges Apply)

**PRODUCT OVERVIEW**

**FRONT:**

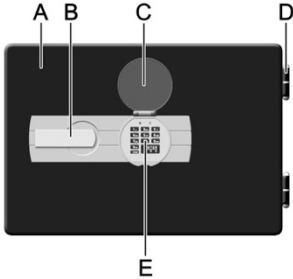

- A - Safe Door
- B - Entry Handle
- C - Keypad Cover
- D - Door Hinges
- E - Electronic Digital Keypad

**INSIDE DOOR:**

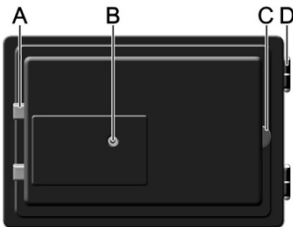

- A - Live locking Bolts
- B - Reset Button
- C - Dead Lock Bolt
- D - Door Hinges

## SETUP & OPERATION

### STEP 1: INSTALL BATTERIES

**IMPORTANT:** The starter batteries included with this product are for testing purposes only and should be immediately replaced with new alkaline or lithium batteries. It is **NOT RECOMMENDED** to use Non-alkaline or rechargeable batteries.

1. The battery compartment is located behind round digital keypad housing. To gain access, turn the housing to the left (counterclockwise) and carefully pull forward and down.
2. Insert 4 “AA” batteries (included). Ensure the batteries are installed in the correct direction, with regard to polarity (+ and -).
3. Re-install battery compartment cover by inserting into the locking holes and turning housing to the right (clockwise).

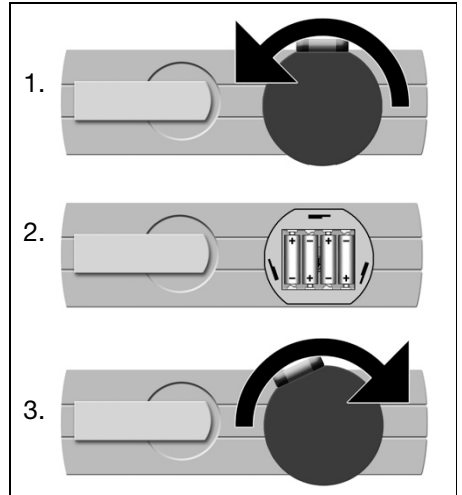

### TO REPLACE BATTERIES:

Weak or dead batteries should be replaced immediately and all 4 batteries should be changed. To replace the batteries please follow the instructions in the SETUP section. Remember to always remove batteries from safe if not using for an extended period of time. If your batteries are completely dead and you cannot open the safe by using the digital keypad, use the override access key to open safe and access the battery compartment.

**IMPORTANT:** When the batteries need replacing, the small Red LED lamp will begin to glow. If the batteries are fully discharged, the digital keypad will not function and the batteries will need to be replaced in order to gain access to the safe.

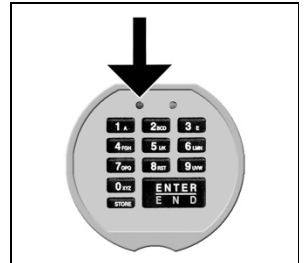

If the batteries are removed or fail, the keypad memory will **NOT** be erased and the active programmed code will still work once power has been restored.

## SETUP & OPERATION

### STEP 2: UNLOCK AND OPEN THE SAFE

1. Lift up on the protective dust cover to gain access to the keypad
2. On the keypad, press “ENTER” then “7 7 7 7” then “ENTER” again.
3. If the correct code has been entered, a musical code will chime, the green LED will blink and the lock will click open.
4. Rotate the handle upwards and pull the door open.

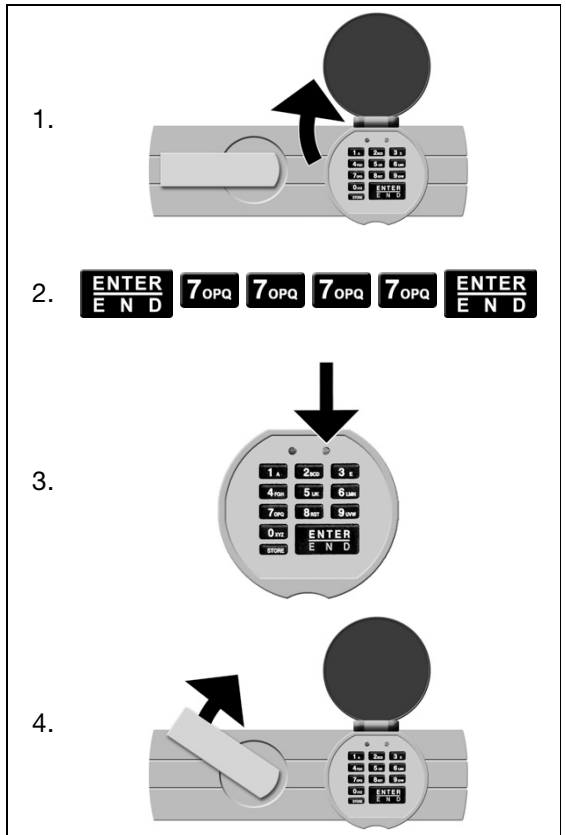

### TO LOCK THE SAFE:

Carefully close the door and rotate the handle downwards. Safe is now in locked position and security code will need to be re-entered to open.

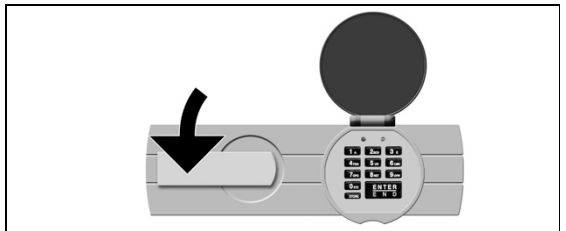

## SETUP & OPERATION

### STEP 3: PROGRAM NEW USER CODES

1. With the door open, press the small black button (B) located near the inside center of the door.

2. You will hear a musical chime and the small green LED will glow.  
NOTE: If the green LED stops glowing, you need to press the black button and start again.

3. Using the digital keypad, you now have approximately 5 seconds to begin entering a new personal code using a minimum of 4 digits to a maximum of 16 digits.

4. Once you have entered new code, press ENTER key. You will hear a chime indicating new code is now programmed into memory.

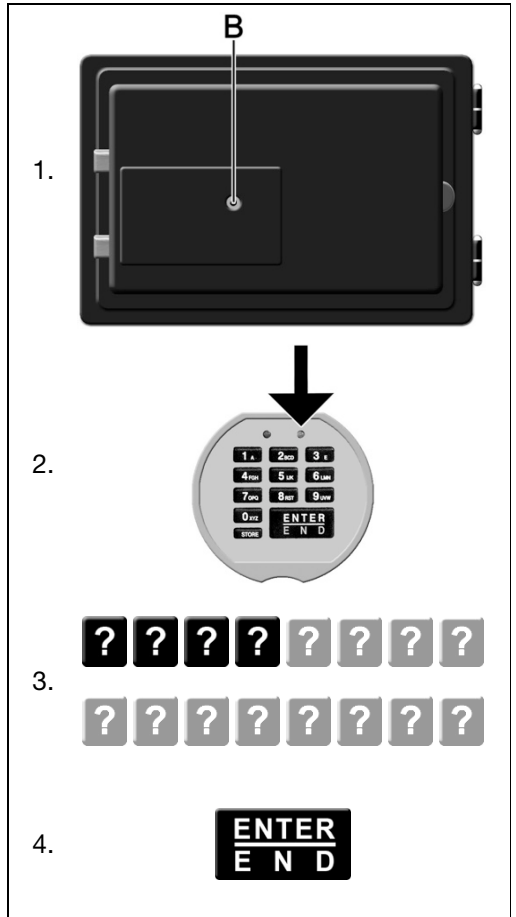

Before closing and locking the safe door, you should enter your new code to confirm that it is correct and unlocks the safe.

For future reference, your new code should be recorded and placed in a secure location away from the safe.

## SECURITY FEATURES

### SECURITY LOCKOUT PERIOD:

If an incorrect code is entered, the LED's will blink and a special two-tone alarm will sound. You should then re-enter the proper code. If an incorrect code is entered 4 times, the safe will enter a security lockout period of about 5 minutes. During this time, you will not be able to enter the safe.

## EMERGENCY ACCESS

### OPEN SAFE WITH EMERGENCY ACCESS KEY

If you have forgotten your personal access code or the electronic lock is not functioning properly, you can use the Emergency Override Key to gain access.

1. The emergency override lock is located behind the batteries under the round digital keypad housing. To gain access, lift the dust cover, rotate the housing to the left (counterclockwise) and carefully pull it forward and down.
2. Temporarily remove the batteries and insert the emergency override key into the lock (K) and turn it counterclockwise to the left.
3. Rotate the handle upwards and pull the door open.
4. Remove the key and replace the 4-AA batteries. Reposition the digital keypad housing into the locking holes and rotate the housing to the right (clockwise).

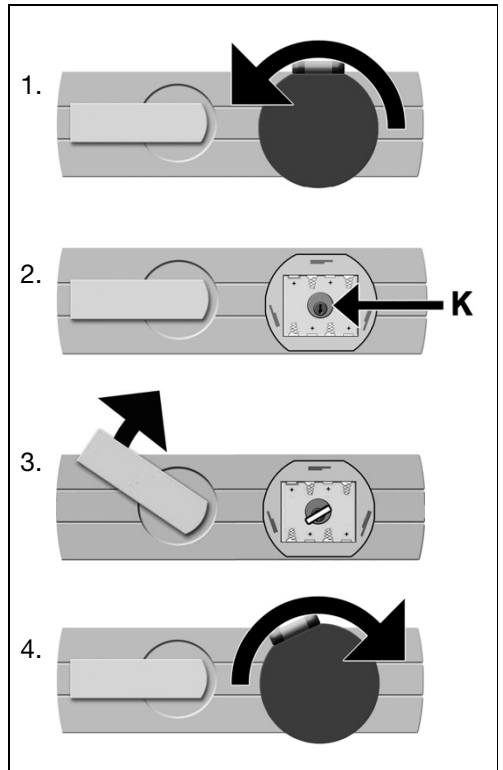

5. Follow Step 3 (Setting New Personal Entry Code) to re-set your code and test as instructed.

# PERMANENT INSTALLATION

## SECURING YOUR SAFE TO THE FLOOR

This safe includes a special knockout insert located on the bottom which allows permanent and secure installation to the floor. Mounting hardware is not included and depending on the type floor (Concrete or wood) it should be purchased separately from your local retailer.

1. Open the safe and remove all the contents (including any shelves if included with safe) and locate the cap in the center of the safe floor. Using pliers, remove the cap by turning counter clockwise (left).
2. To remove the plug you must carefully lay the safe down on the back and remove it by pushing it out with a screwdriver. Once the plug is removed, return the safe to the upright position.
3. Position the safe in the area where you want to secure it and using a marking pen, mark the exact location of the mounting hole.

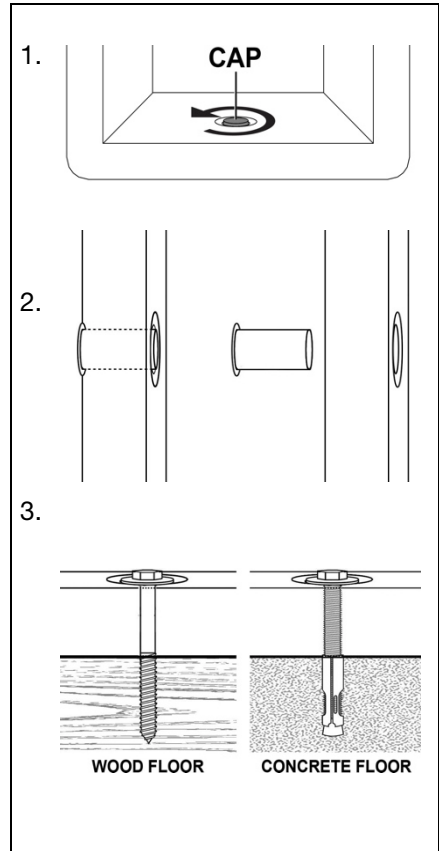

**WOOD** - If installing on a wood floor, a lag screw and large washer should be used to secure the safe to the floor.

**CONCRETE** - If installing on a concrete slab, a concrete insert, screw and large washer should be used.

## ORDERING NEW / REPLACEMENT KEYS

The following information is required to order keys:

### 1. PROOF OF OWNERSHIP (1 of 2 Options Below)

#### SALES RECEIPT & IDENTIFICATION – INTERNATIONAL ORDERS ONLY!

- Copy of sales receipt showing Store, Date & Product Description.
- Copy of your picture I.D. (Drivers license, passport, regular I.D.).

#### PRODUCT OWNERSHIP VERIFICATION FORM

If sales receipt is not available, contact us by email or telephone to request a “Product Ownership Verification Form”.

### 2. ORDER INFORMATION

#### CONTACT INFORMATION

- Name & Shipping Address
- E-mail address (If Available)
- Telephone Number
- Best Time to Contact You

#### PRODUCT INFORMATION

- Safe Model #
- Safe Serial #
- Lock Key #
- Quantity of Keys Ordered

### 3. METHOD OF PAYMENT

- Telephone:  
Visa or MasterCard
- Mail:  
Check or Money Order

NOTE: For pricing please contact Consumer Assistance.  
Contact information is located on the back cover of this manual

Terms subject to change without prior notification.

## SAFE SERIAL NUMBER

Whenever contacting our Consumer Assistance Department, you will need to provide them with the serial number of your safe. The serial number tag is located either on the lower right front or lower front right of the safe.

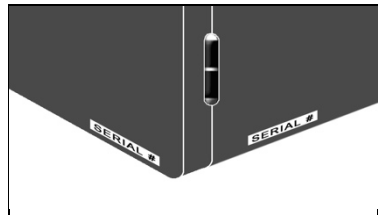



## LIMITED WARRANTY

LH Licensed Products, Inc., (“LHLP, Inc.”) warrants that for a period of seven (7) years from the date of purchase, this product will be free from structural or mechanical defects resulting from materials or workmanship. LHLP, Inc., at its sole option and as the purchaser’s sole remedy under this warranty, will repair or replace this product or any component of the product found to be defective during the warranty period. Replacement or repair will be made with a new or remanufactured product or component. If the product is no longer available, replacement may be made with a similar product of equal or greater value. **THIS IS YOUR EXCLUSIVE WARRANTY.**

This warranty is only valid for the original retail purchaser from the date of initial retail purchase and is not transferable. You must keep the original sales receipt. Proof of purchase is required to obtain warranty service.

LHLP, Inc. dealers, service centers, or retail stores selling this product do not have the right to alter, modify or in any way change the terms and conditions of this warranty.

This warranty does not apply to the finish on the product. This warranty does not cover normal wear and tear of parts or damage resulting from any of the following: negligent use or misuse of the product, use contrary to the operating instructions, disassembly, repair or alteration by anyone other than LHLP, Inc. or an authorized service center, improper installation, or exposure to extremes of heat or humidity. Further, the warranty does not cover Acts of God, such as fire, flood, hurricanes and tornadoes.

LHLP, Inc. shall not be liable for any incidental or consequential damages caused by the breach of any express or implied warranty or otherwise relating to the sale of this product. LHLP, Inc. is also not responsible for: costs associated with removing or installing the product; damage or loss of the contents of the product; nor for the unauthorized removal of the contents; or damages incurred during shipment.

**THE ABOVE WARRANTY IS IN LIEU OF ALL OTHER WARRANTIES, EXPRESS OR IMPLIED, INCLUDING ANY WARRANTIES OF MERCHANTABILITY OR FITNESS FOR A PARTICULAR PURPOSE, AND LHLP, INC. DISCLAIMS ANY AND ALL OTHER COVENANTS AND WARRANTIES.**

Except to the extent prohibited by applicable law, any implied warranty of merchantability or fitness for a particular purpose is limited in duration to the duration of the above warranty period. Some states, provinces or jurisdictions do not allow the exclusion or limitation of incidental or consequential damages or limitations on how long an implied warranty lasts, so the above limitations or exclusion may not apply to you. This warranty gives you specific legal rights, and you may also have other rights that vary from state to state, or province to province, or jurisdiction to jurisdiction.

## LIFETIME AFTER-FIRE REPLACEMENT GUARANTEE

If this Honeywell UL classified fire resistant product was purchased from LH Licensed Products, Inc. (“LHLP”) and is damaged by fire at any time while still owned by you (the original owner), LHLP will ship a free replacement if you send the following to Customer Service, LH Licensed Products, Inc., 860 E. Sandhill Ave., Carson, CA 90746 USA:

1. Your name, mailing address, email address, and phone number with area code;
2. A description of the fire, the model number and a photo of the burned unit, and a copy of the report from the fire department, insurance or police.

Freight on the replacement unit is not included in the guarantee and must be paid by the consumer. If an identical product is no longer available, LHLP will provide a similar unit from its current product line. LHLP is not responsible for any loss or damage to the contents of the safe.

## CONSUMER ASSISTANCE

EMAIL (Best Contact Method): LHLPCustomerService@LHLPinc.com

WEBSITE: www.Honeywellsafes.com (Effective April 15, 2013)

ADDRESS: Consumer Assistance Dept.  
LH Licensed Products, Inc.  
860 East Sandhill Avenue  
Carson, CA 90746 USA

TELEPHONE: **US/Canada** 1-877-354-5457 (Toll Free)  
**Mexico** 01-800-288-2872 After English voice recording stops you must then enter 800-860-1677 to complete your call. (Toll Free)  
**Australia** 0011-800-5325-7000 (Toll Free)  
**Germany/New Zealand** 00-800-5325-7000 (Toll Free)

**Other Countries** XX\*-310-323-5722 (Toll Charges Apply)  
XX\*- Dial U.S. Country Code first

CALL CENTER HOURS: **US/Canada** 7am – 5pm (PST\*\*) Mon – Fri

CALL BACK HOURS: **Other Countries** 7am – 8pm (PST\*\*) Mon – Fri  
PST\*\*- Local time in Los Angeles, CA, USA

### INTERNATIONAL CALL BACK HOURS:

If you need to speak with a consumer assistant and cannot contact us during the Call Center hours above, please send an email or leave a telephone message, including your Name, Telephone Number and the best time for us to contact you during the Call Back hours above and we will make our best effort to contact you and help to answer any of your questions or concerns.

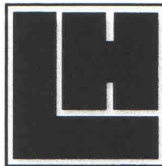

Manufactured by  
LH Licensed Products, Inc.  
860 East Sandhill Avenue  
Carson, CA 90746

The Honeywell Trademark is used under license from Honeywell International Inc. Honeywell International Inc. makes no representations or warranties with respect to this product.